

UNMATCHED BOLDNESS. UNRIVALED DOMINANCE.

Presenting the imposing new Innova Crysta.



NEW
INNOVA
CRYSTA | **UNMATCHED**
UNRIVALED



UNMATCHED UNRIVALED

The Innova Crysta has been India's favourite family car for over 15 years. It has been followed by many, but matched by none. Its power, comfort and safety are unparalleled and part of automobile folklore.

Now the legendary Innova's capabilities are further enhanced with an imposing new front silhouette that gives it a bold stance unlike any other car. The new Innova Crysta also gets stunning diamond-cut alloy wheels that make it look more sporty and formidable from all the rest. In short, the new Innova Crysta is in a league of its own.

Distinctly designed, its exterior body lines are only a prelude to the luxuries that's inside. Nothing can prepare you for the unbelievable space and plushness of its luxurious cabin.

Replete with cozy, leather* reclining seats that give you more legroom, and ride quality that's second to none, the new Innova Crysta is truly beyond compare. Add to that its raw, yet refined power delivery and you have a car that gives you a truly unmatched and unrivaled travelling experience.

UNMATCHED DESIGN

The new Innova Crysta's design is matchless. Thanks to its distinctly styled, bold front grille and bumper, it exudes unmistakable road presence that takes it miles ahead of the rest.

Piercing Headlamps

Improves visibility and enhances the confident stance

Enticing Diamond-cut Alloys

Gives more style & presence to your drive

Welcome Lamps

Provides a warm welcome everytime you approach the new Innova Crysta

Imposing Trapezoid Piano Black Grille

New bold front grille with chrome surround and stylish bumper

Front Clearance Sonar with MID Indication

Ensures safe parking in tight spaces



UNRIVALED CONNECTIVITY

The elegant driver dashboard is the control centre of the new Innova Crysta. While it is decked with a new 8.0 display with Android Auto and Apple CarPlay, it is also loaded with advanced connectivity* functions like Walk to Car, Geo Fencing and Real Time Vehicle Tracking. Moreover, it houses convenient, easy-to-reach features and a clever, crystal clear instrument cluster that keeps track of your journey wherever you go.



Apple CarPlay | Android Auto

Access your favourite Apple and Android apps



Blue Illumination, 3-dimensional Combination Meter with Large TFT MID

Blue illumination, 3-dimensional combination meter with large TFT MID with drive information, cost calculator and telephone/navigation display adds to the car's intelligence

INNOVA CONNECTED - SECURITY REDEFINED*

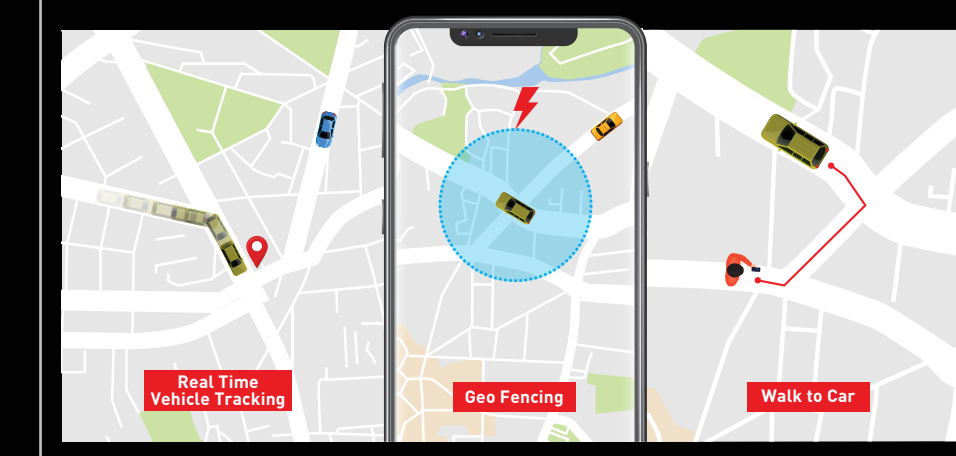

*Recommended accessory. Not standard fitment.

UNMATCHED COMFORT



Plush Leather[#] Seats | Choose from a range of premium leather[#] seats in hazel brown, black and camel tan



One-touch Tumble Second Row Seat | Gives you easy access to the third row seats



Ambient Illumination | Gives the cabin a luxurious look and feel

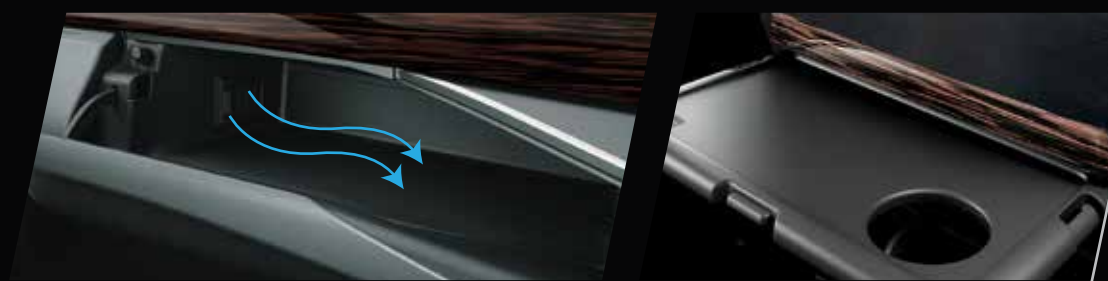

Upper Glove Box with Cooling
| Keeps your beverages cold and refreshingly fresh

Foldable Seatback Table with Cup Holder
| Keeps your knick knacks safely when on the go



Wood Finish Interior Panels | Gives a premium and luxurious look



Easy Slide Front Passenger Seat
| Adjusts the rear legroom for more comfort



Smartphone Holder with USB Port
| Keeps you connected when on the move

The interior of the new Innova Crysta is unequalled in its refinement and class. While the sheer amount of space will thrill you, the built-to-last quality will mesmerise you.

Be it the choice of premium leather[#] seats, enhanced legroom or soft-touch materials, the new Innova Crysta spells unparalleled comfort.

So whether it's a long journey or a short trip, it gives you the calm and composure needed for you to arrive in style and confidence at your destination.

[#]Mix of genuine and synthetic leather.

UNRIVALED PERFORMANCE



The new Innova Crysta has oodles of power under its hood. Yet it is unwaveringly efficient as it returns more miles for the gallon. And that's not all. It also offers refined driving dynamics for a smoother, more surefooted ride thanks to its robust chassis, sturdy suspension and slick transmission.



ECO & POWER Drive Modes | ECO mode for optimum fuel economy and POWER mode for sharper acceleration response



6 Speed ECT with Sequential Shift | 6 speed super intelligent electronically controlled automatic transmission that draws out the engine's maximum potential



Powerful GD Diesel Engine

The new Innova Crysta is powered by a GD diesel engine with further evolved low-speed torque. It has improved fuel economy while torque in the low and medium speed ranges have been considerably increased.



New Refined Petrol Engine

The refined petrol engine, delivering a power output of 122 KW places the Innova Crysta notches above the rest. It has relatively low weight that reduces fuel consumption. Dual Variable Valve Timing with Intelligence and (Dual VVT-i) ensures a more smoother, efficient drive.



Improved Suspension with Pitch & Bounce Control

Keeps cabin movement to a minimum and maintains a smooth ride on rough roads

UNMATCHED SAFETY



The new Innova Crysta is not only powerful and comfortable, it's safe too. Because, at Toyota we give your safety the utmost priority.

The new Innova Crysta protects you and your family with 7 SRS Airbags[#] during any eventuality. Anti-lock braking, electronic brake force distribution, brake assist and the like ensure safety and stability even while high-speed braking.

The tough chassis and the acclaimed GOA Body keeps body roll to a minimum and ensures maximum protection by evenly distributing any impact on the car throughout the body of the car.

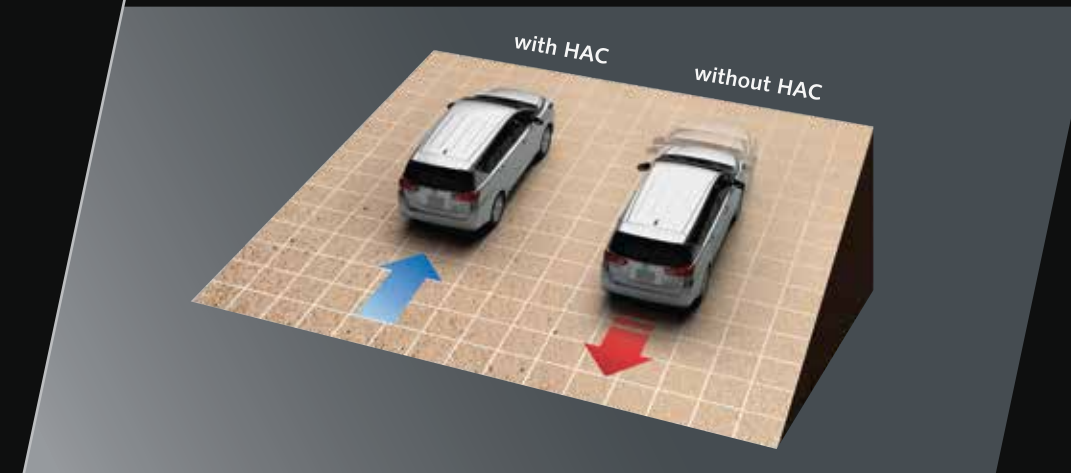

Hill-start Assist Control | Automatically controls the brakes suppressing vehicle rollback when starting off on a slope, reducing the burden on the driver

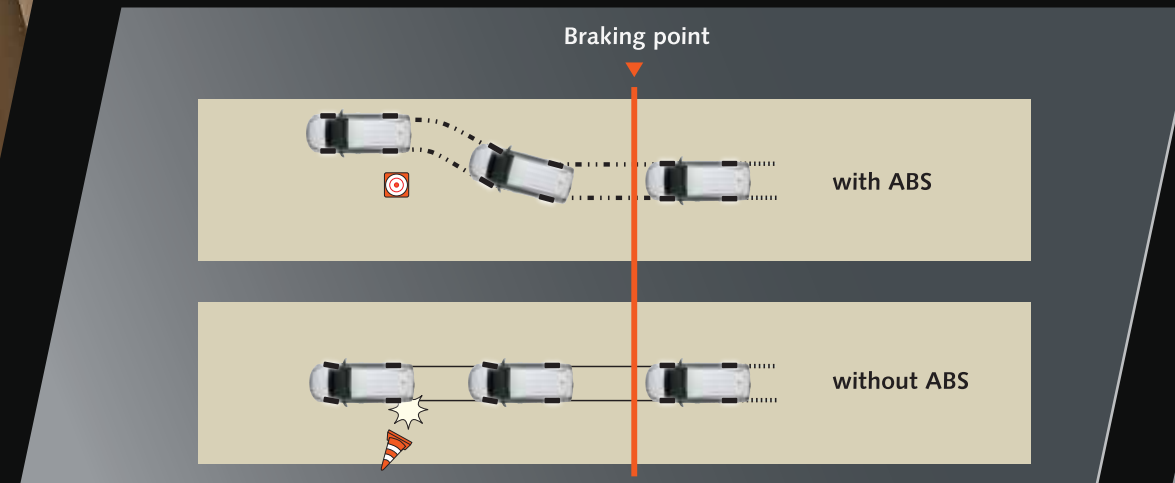

Anti-lock Braking System | Prevents wheels from locking and enables greater manoeuvrability and steering control

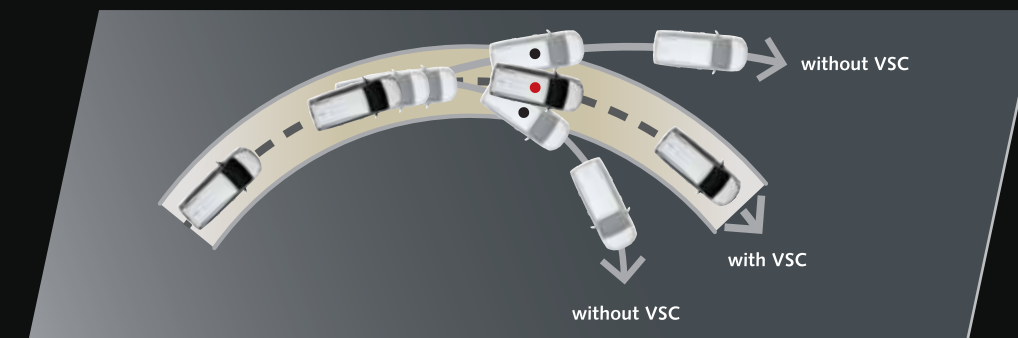

Vehicle Stability Control | Automatically controls both vehicle brakes and engine output during over steer or under steer while the vehicle is making a turn, ensuring vehicle stability

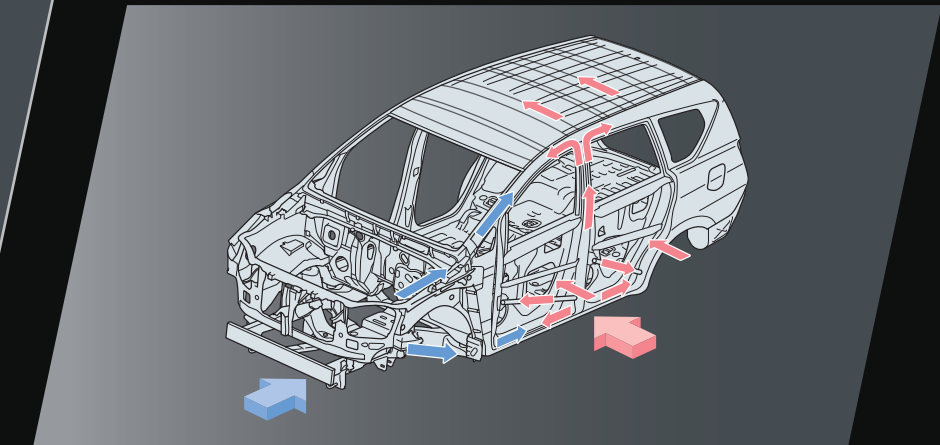

GOA Body | High strength body structure that effectively absorbs impacts and distributes it evenly during unforeseen collisions, thereby reducing passenger and pedestrian injuries

[#]For more details on the functioning of Airbags please refer to the owner's manual



UNRIVALED UPGRADES

The new Innova Crysta is decked with all the features you expect. But we always have scope for enhancements.

You can enhance the appeal, convenience and comfort of your new Innova Crysta with these amazing accessories.



Roof Spoiler Garnish
| Enhances elegance and improves downforce

SPECIFICATIONS

GRADE	G		G		V		Z		Z		
	X		X		X		X		X		
	MANUAL		AUTOMATIC		MANUAL		MANUAL		AUTOMATIC		
ENGINE TYPE	DIESEL	PETROL	DIESEL	PETROL	DIESEL	PETROL	DIESEL	PETROL	DIESEL	PETROL	
SEATING CAPACITY	7 / 8 SEATER	7 / 8 SEATER	7 / 8 SEATER	7 / 8 SEATER	7 / 8 SEATER	7 SEATER	7 SEATER	7 SEATER	7 SEATER	7 SEATER	
ENGINE, TRANSMISSION & CHASSIS											
DISPLACEMENT	2 393 cm ³ (cc)	2 694 cm ³ (cc)	2 393 cm ³ (cc)	2 694 cm ³ (cc)	2 393 cm ³ (cc)	2 694 cm ³ (cc)	2 393 cm ³ (cc)	2 694 cm ³ (cc)	2 393 cm ³ (cc)	2 694 cm ³ (cc)	
DRIVE MODES	ECO & POWER MODE										
MAX. OUTPUT	110 kW (150 PS) @ 3 400 rpm	122 kW (166 PS) @ 5 200 rpm	110 kW (150 PS) @ 3 400 rpm	122 kW (166 PS) @ 5 200 rpm	110 kW (150 PS) @ 3 400 rpm	122 kW (166 PS) @ 5 200 rpm	110 kW (150 PS) @ 3 400 rpm	110 kW (150 PS) @ 3 400 rpm	110 kW (150 PS) @ 3 400 rpm	122 kW (166 PS) @ 5 200 rpm	
MAX. TORQUE	343 Nm @ 1 400 - 2 800 rpm	245 Nm @ 4 000 rpm	360 Nm @ 1 400 - 2 600 rpm	245 Nm @ 4 000 rpm	343 Nm @ 1 400 - 2 800 rpm	245 Nm @ 4 000 rpm	343 Nm @ 1 400 - 2 800 rpm	343 Nm @ 1 400 - 2 800 rpm	360 Nm @ 1 400 - 2 600 rpm	245 Nm @ 4 000 rpm	
TRANSMISSION	5 SPEED MANUAL		6 SPEED AUTOMATIC WITH SEQUENTIAL SHIFT		5 SPEED MANUAL		5 SPEED MANUAL		6 SPEED AUTOMATIC WITH SEQUENTIAL SHIFT		
TYRES	205 / 65 R16 WITH ALLOY WHEELS						215 / 55 R17 WITH ALLOY WHEELS				
EXTERIOR											
RADIATOR GRILLE	NEW DESIGN BLACK & SILVER				NEW DESIGN PREMIUM BLACK & CHROME						
HEADLAMP	MULTIREFLECTOR				AUTOMATIC LED PROJECTOR, HALOGEN WITH LED CLEARANCE LAMP						
OUTSIDE REAR VIEW MIRROR	BODY COLOURED, ELECTRIC ADJUST & RETRACT WELCOME LIGHTS WITH SIDE TURN INDICATORS						CHROME, ELECTRIC ADJUST & RETRACT WELCOME LIGHTS WITH SIDE TURN INDICATORS				
INTERIOR											
INDIRECT BLUE AMBIENT ILLUMINATION	x		x		√		√		√		
STEERING WHEEL	URETHANE WITH SILVER ORNAMENT AND SWITCHES FOR AUDIO, TELEPHONE, MULTI INFORMATION DISPLAY				LEATHER WRAP WITH SILVER & WOOD FINISH ORNAMENT AND SWITCHES FOR AUDIO, TELEPHONE, VOICE RECOGNITION, MULTI INFORMATION DISPLAY						
SPEEDOMETER	WITH MULTI INFORMATION DISPLAY				BLUE ILLUMINATION, 3D DESIGN WITH TFT MULTI INFORMATION DISPLAY & ILLUMINATION CONTROL						
MULTI INFORMATION DISPLAY (MID)	DOT TYPE MID WITH DRIVE INFORMATION (FUEL CONSUMPTION, CRUISING RANGE, AVERAGE SPEED, ELAPSED TIME, ECO INDICATOR) OUTSIDE TEMPERATURE		DOT TYPE MID WITH DRIVE INFORMATION (FUEL CONSUMPTION, CRUISING RANGE, AVERAGE SPEED, ELAPSED TIME, ECO INDICATOR), OUTSIDE TEMPERATURE, SHIFT POSITION INDICATOR		TFT MID WITH DRIVE INFORMATION (FUEL CONSUMPTION, CRUISING RANGE, AVERAGE SPEED, ELAPSED TIME, ECO DRIVE INDICATOR & ECO SCORE, ECO WALLET), OUTSIDE TEMPERATURE, AUDIO DISPLAY, PHONE CALLER DISPLAY, WARNING MESSAGE				TFT MID WITH DRIVE INFORMATION (FUEL CONSUMPTION, CRUISING RANGE, AVERAGE SPEED, ELAPSED TIME, ECO DRIVE INDICATOR & ECO SCORE, ECO WALLET), OUTSIDE TEMPERATURE, AUDIO DISPLAY, PHONE CALLER DISPLAY, WARNING MESSAGE, SHIFT POSITION INDICATOR		
SEATS, COMFORT & CONVENIENCE											
AIR CONDITIONER	MANUAL CONTROL (FRONT & REAR)				AUTOMATIC CLIMATE CONTROL WITH COOL START AND REGISTER ORNAMENT						
FRONT SEAT					SEPARATE SEATS WITH SLIDE & RECLINE, DRIVER SEAT HEIGHT ADJUST						
8-WAY POWER ADJUST DRIVER SEAT	x		x		x		√		√		
SEAT COVER MATERIAL	BLACK FABRIC				PREMIUM BLACK FABRIC WITH STITCHED 'CRYSTA' INSIGNIA**		PREMIUM BLACK FABRIC		OPTION OF PERFORATED BLACK OR CAMEL TAN LEATHER* WITH EMBOSSED "CRYSTA" INSIGNIA**		HAZEL BROWN LEATHER
AUDIO											
SMART PHONE CONNECTED AUDIO [ANDROID AUTO & APPLE CARPLAY]	√		√		√		√		√		
POWER OUTLET	12 V x 2 UNITS				USB FAST CHARGING PORT**, 12 V x 2 UNITS						
HEAT REJECTION GLASS	x		x		√		x		√		
SMART ENTRY SYSTEM	x		x		√		√		√		
WIRELESS DOOR LOCK	WITH JACK-KNIFE KEY				WITH SMART ENTRY KEY & PUSH START / STOP BUTTON						
EASY CLOSER BACK DOOR	x		x		x		√		√		
CRUISE CONTROL	x		√		√***		√		√		
SEAT BACK TABLE	x		x		√		√		√		
TILT & TELESCOPIC STEERING COLUMN	√		√		√		√		√		
SAFETY & SECURITY											
SRS AIRBAG**					DRIVER, FRONT PASSENGER & DRIVER KNEE AIRBAGS** (3 UNITS)				DRIVER, FRONT PASSENGER, DRIVER KNEE, FRONT SIDE, CURTAIN SHIELD AIRBAGS** (7 UNITS)		
ABS WITH EBD & BA	√		√		√		√		√		
VEHICLE STABILITY CONTROL	√		√		√		√		√		
HILL START ASSIST CONTROL	√		√		√		√		√		
FRONT & REAR CLEARANCE SONAR WITH MID INDICATION	REAR ONLY				√		√		√		

*Mix of Genuine and Synthetic Leather. **Grade E G & G Plus are made to order. For the detailed specification sheet please refer brochure. -Diesel variants only. **Perforation, Embossing and Ivory color on Diesel variants only. ^ ^ USB Fast Charging on Diesel variants only. **For more details on the functioning of Airbags please refer to the owner's manual. *Available only in VX and above models. **Available only in GX & above models. ***Not available in taxi variant.



Welcome Door Lamp
| Inviting lamp that welcomes you inside the vehicle



Wireless Charger
| Charges your smartphone smartly



Digital Video Recorder
| Records the traffic in front of the car for playback later



Tire-pressure Monitoring System
| Keeps track of tire pressure wherever you go





www.toyotaconnect.in



UNMATCHED WARRANTY*

3 years / 1 00 000 km
*Conditions Apply

For more information, visit www.toyotabharat.com
You can Talk to Toyota at **1800-425-0001**
(BSNL/MTNL Toll Free No.)
or **+91-80-66293001** (Direct No.)

Note: Vehicles pictured and specifications detailed in this brochure may vary between models and equipment. Addition of extra features may change figures in this chart. Toyota Kirloskar Motor Pvt. Ltd. reserves the right to alter the details of specifications and equipment without a notice. Actual colour of the vehicle body & upholstery might differ slightly from the images depicted in this brochure. Features are grade specific.

Stay tuned for more updates:  /ToyotaIndia

 /Toyota_India

 /toyota.india

 /ToyotainIndia

 +91 4071781588

Is your Innova Crysta Dealer